

version .0

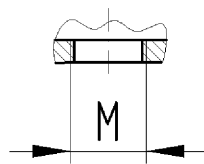
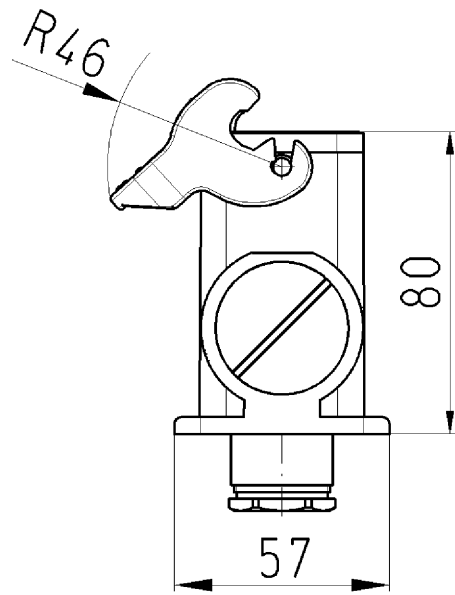
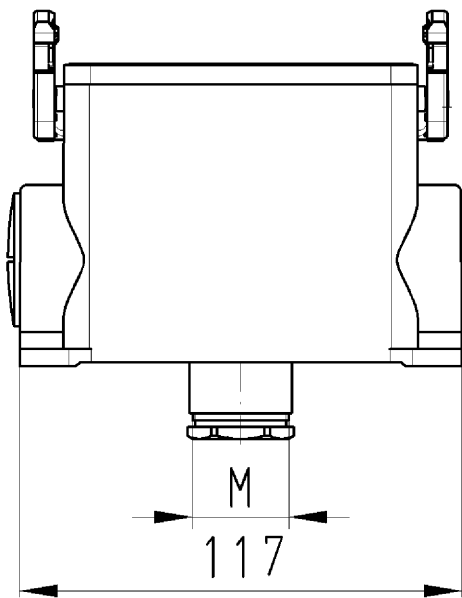

version .1

Gehäuseunterteil
76.333.4035.0

Zeichnungsnummer
76.333.4035.010W
Gehäuseunterteil

04.01.2008
Hoffmann Angelika
M 1:2